

## ROTARY LOBE PUMP

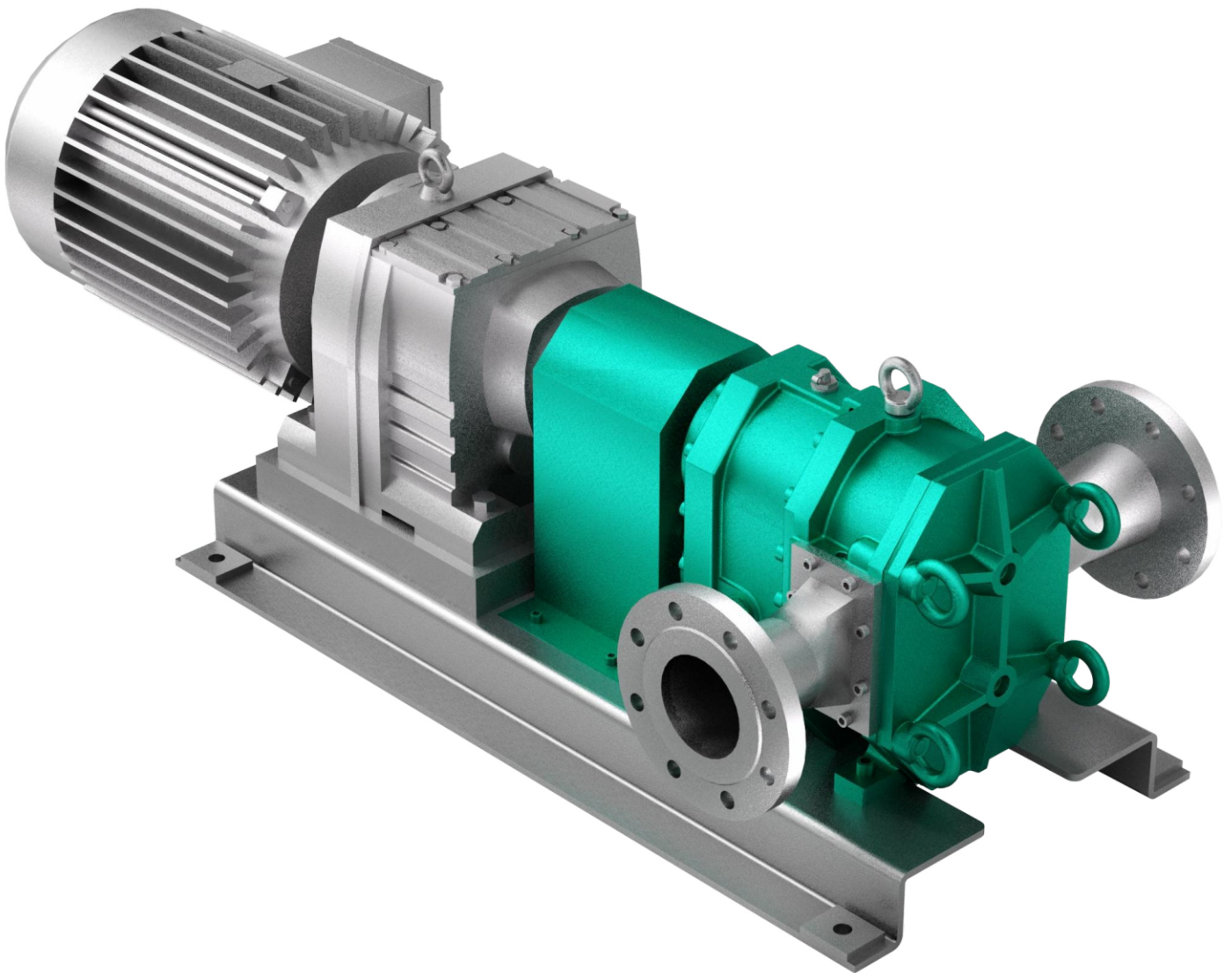

## Working principle and suitable medium for conveying

rotary lobe pumps are self-priming, valveless, positive displacement pumps. Two synchronously reversed rotors mesh with each other and form a small cavity with the pump cavity. The medium filled in the cavity is constantly pushed from the inlet end to the outlet end by the rotating rotor. The design structure of the lobe pump is completely symmetrical. By changing the rotation direction of the pump, the flow direction of the pump can be changed, and reversible operation can be easily realized. Lobe pump (rotor pump) meets API676 or SH/T 3151 standard.

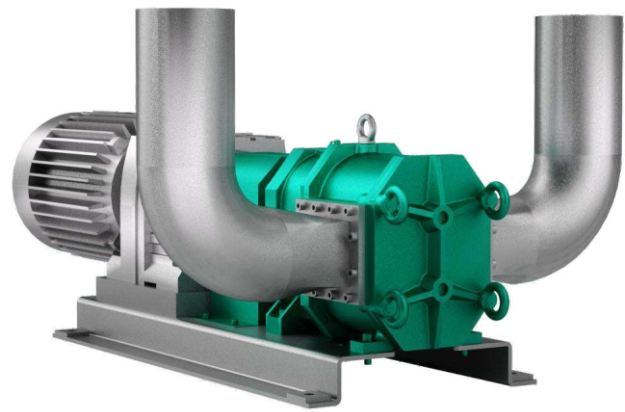
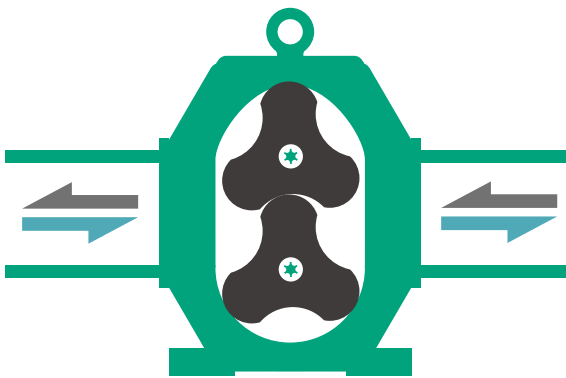

## Suitable medium for conveying

The squeezing and shearing of the medium by the rotary lobe pump is extremely small, and there is almost no pulse and disturbance. Suitable for conveying high viscosity medium, containing solid particles liquid, high abrasiveness liquid, Shear-sensitive medium, gas-liquid mixture, and fluids with quantitative feeding.

## Technical advantages

1. Strong self-priming: the maximum suction distance can reach 8.5-9.5 meters
2. Excellent wear resistance
3. Online maintenance
4. Can be dry running
5. Energy saving and power saving, high efficiency
6. Reversible flow direction
7. Mixed transport of multi-phase media: mixed transport of gas, liquid and solid
8. No clogging
9. Ultra-wide medium viscosity delivery range
10. Compact structure, small footprint

## Structure

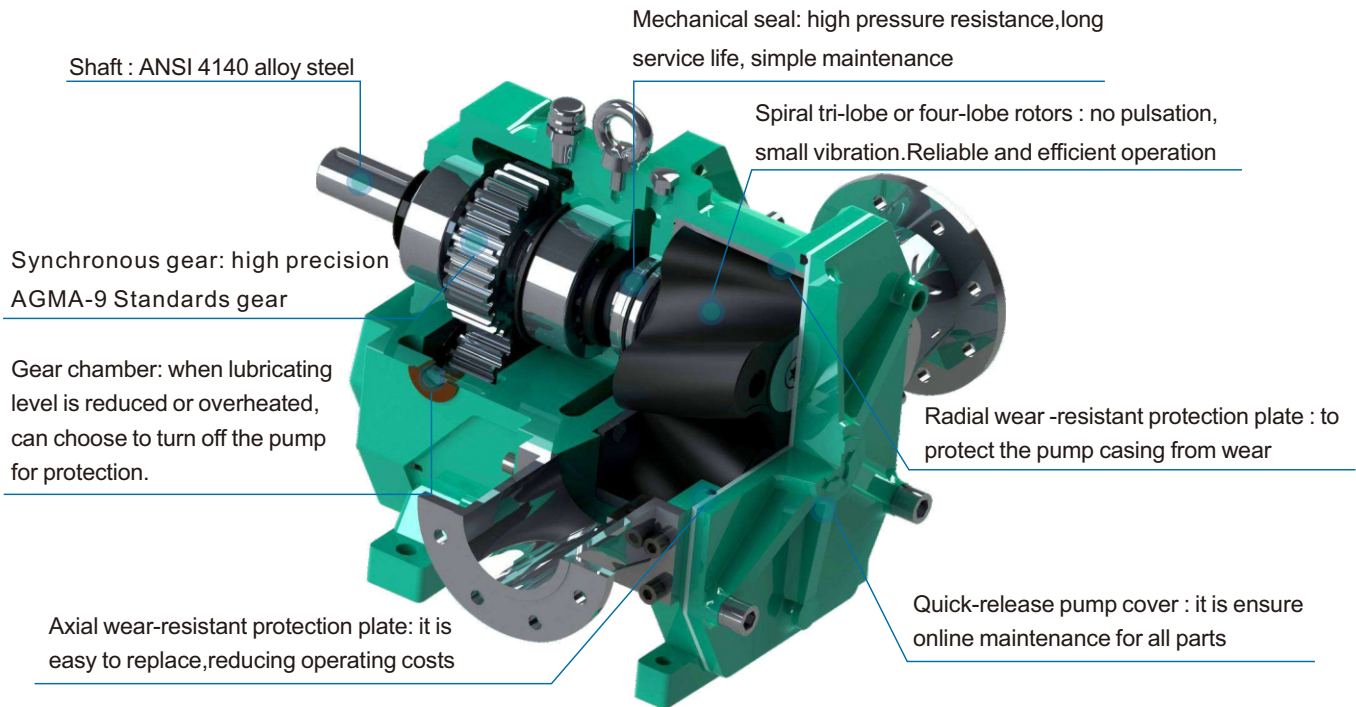

## Easy maintenance

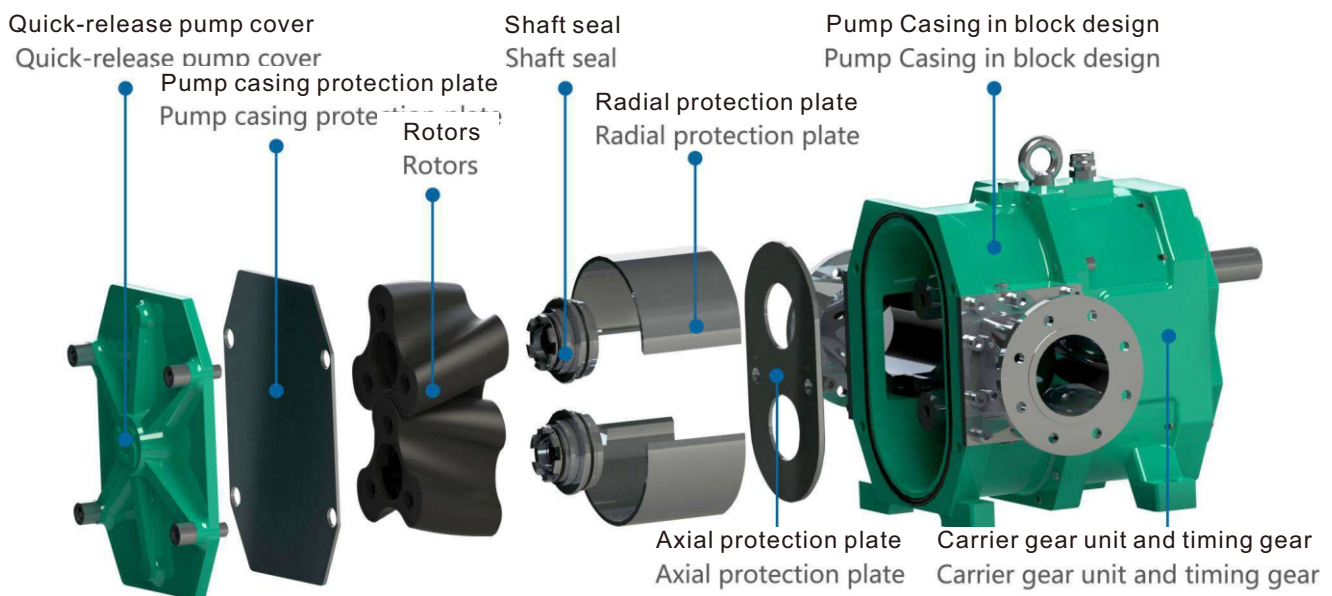

The structural design of the Accuvon rotary lobe pump is very simple, and all models of the pump retain a simple design style. The quick-release pump cover provides convenience for the maintenance of the pump without dismantling the pipeline.

## Various rotor



"Wide side" rotor

More wear-resistant, stronger self-priming, higher efficiency



Different rotor forms and materials meet the diverse needs of users, such as NBR , FKM , EPDM , PU , CSM polyethylene synthetic rubber, stainless steel, copper, wear-resistant steel, PTFE, etc., Our pumps of the same size range are available in a variety of rotor styles and materials. Almost any needs of customers are met.

## Mechanical seal technology



The sealing forms of Accuvon rotary lobe pump include single-acting self-lubricating mechanical seal, single-acting cartridge mechanical seal, double-acting cartridge mechanical seal, multiple skeleton seal and packing seal etc. The sealing surface material is SIC, Carbide etc. In various complex applications such as petroleum, chemical industry, sewage treatment, lithium battery, etc., it can be handled calmly. The mechanical seal meets the API682 standard, and also provides a variety of flushing or cooling systems that match the mechanical seal.



## Various installation designs of rotary lobe pump

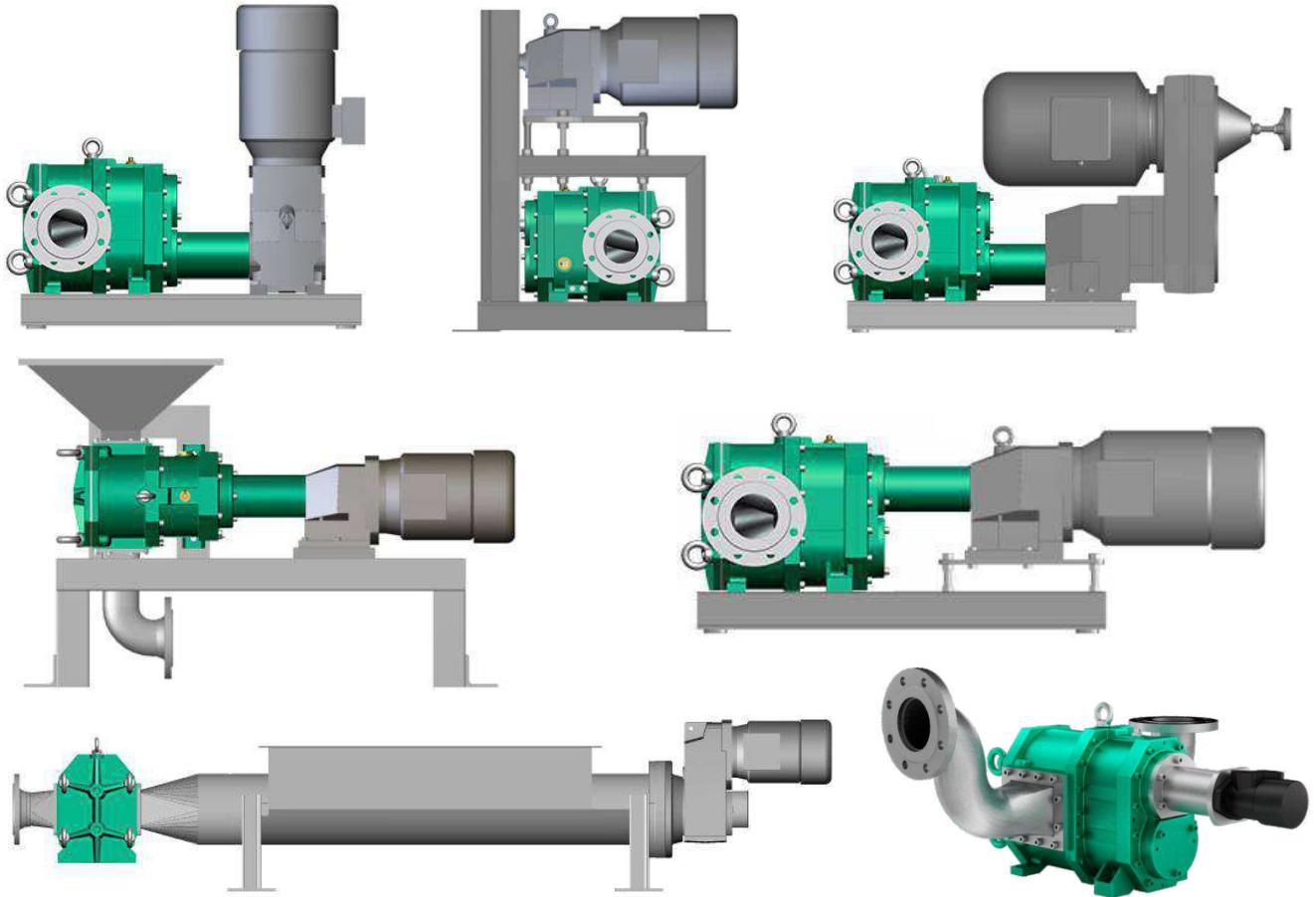

## Different pipe connection options

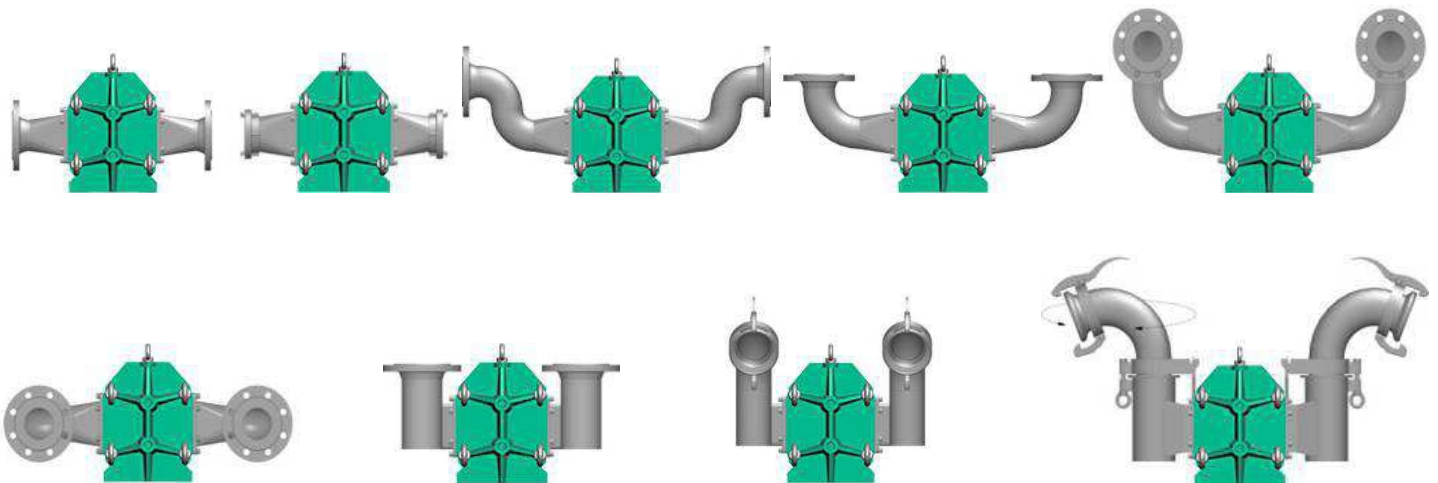

## Model and performance parameters

4 Series with 16 models constitute the perfect product line of Accuvon rotary lobe pumps. The maximum flow rate is up to 3200m<sup>3</sup>/h, the maximum pressure is up to 2.5MPa and the flow rate of 5000m<sup>3</sup>/h is under development. The modular design of the pump makes the same commonality of the same series and increases the universal interchangeability of parts.

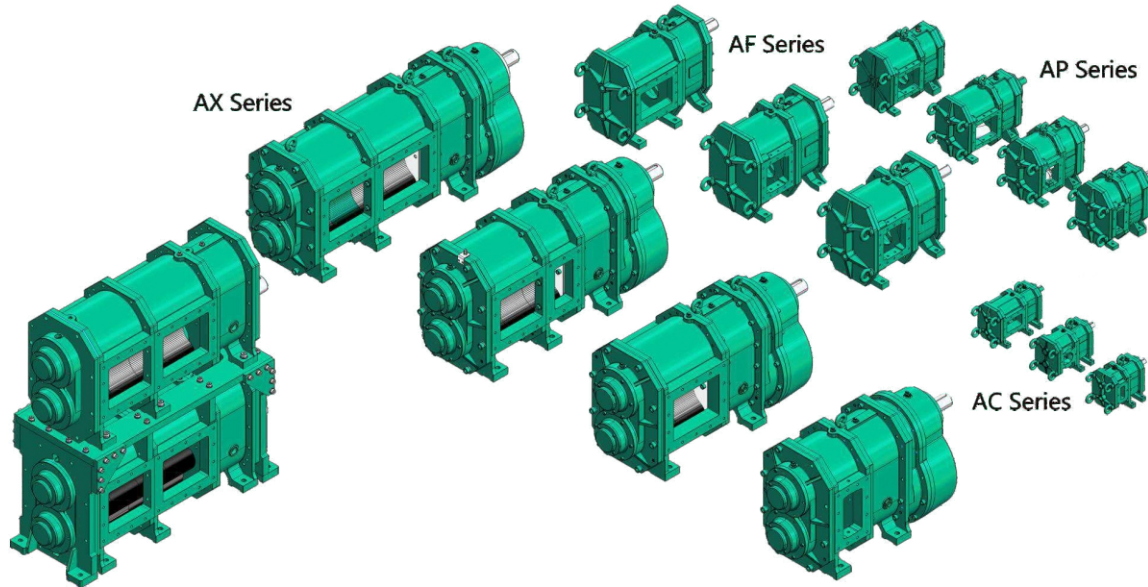

Series	Model	Stroke Volume	Flow	Max. Pressure	Advice	Speed	Standard	Optional flange	Power
		l/r	m <sup>3</sup> /h	Mpa	rpm	rpm	mm	mm	Kw
AC	AC25	0.196	1~5	1.2	≤350	25~650	DN25	DN20/DN40	0.75~3
	AC50	0.392	6~8	1.0	≤350	25~650	DN50	DN40/DN65	1.1~5.5
	AC75	0.588	9~15	0.6	≤350	25~500	DN50	DN65/DN80	1.5~5.5
AP	AP80	1.125	18~25	1.8	≤350	25~500	DN80	DN65/DN100	2.2~22
	AP100	1.857	28~38	1.4	≤350	25~500	DN100	DN80/DN125	3~22
	AP120	2.864	40~60	1.0	≤350	25~500	DN100	DN80/DN125	5.5~22
	AP140	3.714	60~80	0.6	≤350	25~500	DN125	DN100/DN150	7.5~22
AF	AF125	4.566	85~110	1.6	≤350	25~500	DN125	DN100/DN150	11~75
	AF150	6.828	120~160	1.2	≤350	25~500	DN150	DN125/DN200	15~75
	AF200	9.456	170~220	0.8	≤350	25~500	DN200	DN150/DN250	15~75
AX	AX250	12.5	230~300	2.5	≤350	25~650	DN250	DN200/DN300	22~450
	AX300	25	300~750	1.0	≤350	25~650	DN300	DN250/DN350	22~600
	AX350	37.5	800~1200	0.6	≤350	25~650	DN350	DN300/DN400	30~600
	AX450	50	1300~1600	0.4	≤350	25~650	DN450	DN400/DN500	30~600
	AX350D	75	1600~2400	0.6	≤350	25~650	DN350*2		55~600
	AX450D	100	2600~3200	0.4	≤350	25~650	DN450*2		55~600



## Application field

**Petrochemical:** Sewage oil and sewage lifting pumps, oil and chemical products unloading pumps, tank bottom oil pumps, waste oil recovery pumps, warehouse and line sweeping pumps, oil sludge delivery pumps, petroleum skid installation systems, gas-liquid mixed pumps wait. (Common media: gasoline, diesel, jet fuel, naphtha, heavy oil, fuel oil, crude oil, residual oil, methanol, ethanol, polyols, concentrated sulfuric acid, liquid caustic soda, phosphoric acid, sludge, dirty oil, grease, lubricating oil, Viscous oil, asphalt, catalyst, oily sewage, domestic sewage, accident water, rainwater, etc.)

**Environmental protection:** sludge feed pump, sludge return pump, excess sludge pump, floating sludge pump, concentrated sludge pump, bridge type suction machine sand pump, sewage sludge lift pump, landfill leachate lift pump, MBR treatment (negative pressure suction pump, pickling and alkali washing backwash pump), mud cake pump, lime slurry dosing pump, powdered activated carbon dosing pump, dosing metering pump, etc.

**Chemicals:** fine chemicals (chemical raw materials, chemical additives, adhesives, emulsion explosives, 107 glue, silicone oil, glycerin, coatings, resins and polymers, dyes, gypsum, iron white powder, etc.); daily chemicals (LAS, AES, AOS, MES, K12, sorbitol, skin cream, nutritional cream, cosmetics, dental tone, facial cleanser, lotion, shampoo, body wash, liquid soap, soap, detergent, laundry powder slurry, etc.)

**Railway:** Vacuum sewage system, cam type airtight pumping station, cam type airtight sewage lifting device, On-line rotary lobe pump unit (vacuum unloading system of railway train station), vacuum discharge system for railway stations, vacuum discharge system for subway, etc.

**Biogas:** kitchen waste, landfill leachate, expired food, animal manure (pig manure delivery pump, cow manure delivery pump), various organic matter, etc.

**Lithium battery:** positive and negative electrode material slurry, conductive additives, battery slurry, vacuum defoaming, stirring, coating process, etc.

**Medicine:** Pill paste, extract, emulsion, ointment, etc.

**Ships:** bilge wastewater, domestic sewage, waste oil, sludge, fuel oil, etc.

**Confectionery:** syrup, cream, chocolate, etc.

**Ceramics:** clay, lime slurry, colored glaze, iron oxide mud, etc.

**Food:** tomato paste, fruit puree, vegetable paste, pudding, jam, fruit filling, flavoring, sweetener, jelly, yeast puree, salad, seasoning, pastry, etc.

**Beverages:** beer, diatomaceous earth, wort, yeast, soft drinks, fruit concentrates, juice drinks, etc.

**Dairy products:** yogurt, whipped cream, ice cream, cheese, etc.

**Papermaking:** pulp, additives, latex, etc.

**Meat:** animal offal and blood, animal meat, etc.

**Construction:** hotels, sports grounds, exhibition halls, railway stations, ship terminals, groundwater discharge, etc.

**Transportation:** special tank truck, vacuum sewage truck, etc.

